

# pehlivan

## *SOLAR TEAM*

 Pehlivan Solar Team

 @pehlivanteam

#günesinpehlivanları





**BİLGİLENDİRME**  
**ve**  
**TOPLANTILAR**



## ŞASE-GÖVDE

**Şase**  
Güneş arabalarının temelini şase oluşturur. ekipmanların ve gövdenin, üstünde bir araya gelmişlerdir. Yapılmış araba temelleri sadece göze değil, dayanıklı ve güvenli bir yapıya sahiptir. Şase ve gövde bir arada çalışır ve birbirini destekler.

Şase arabaların temelini oluşturur ve şase şase ve gövde bir arada çalışır ve birbirini destekler.

- 1. Kuvvet
- 2. Dayanıklılık
- 3. Esneklik
- 4. Uzun ömür











**TASARIM**

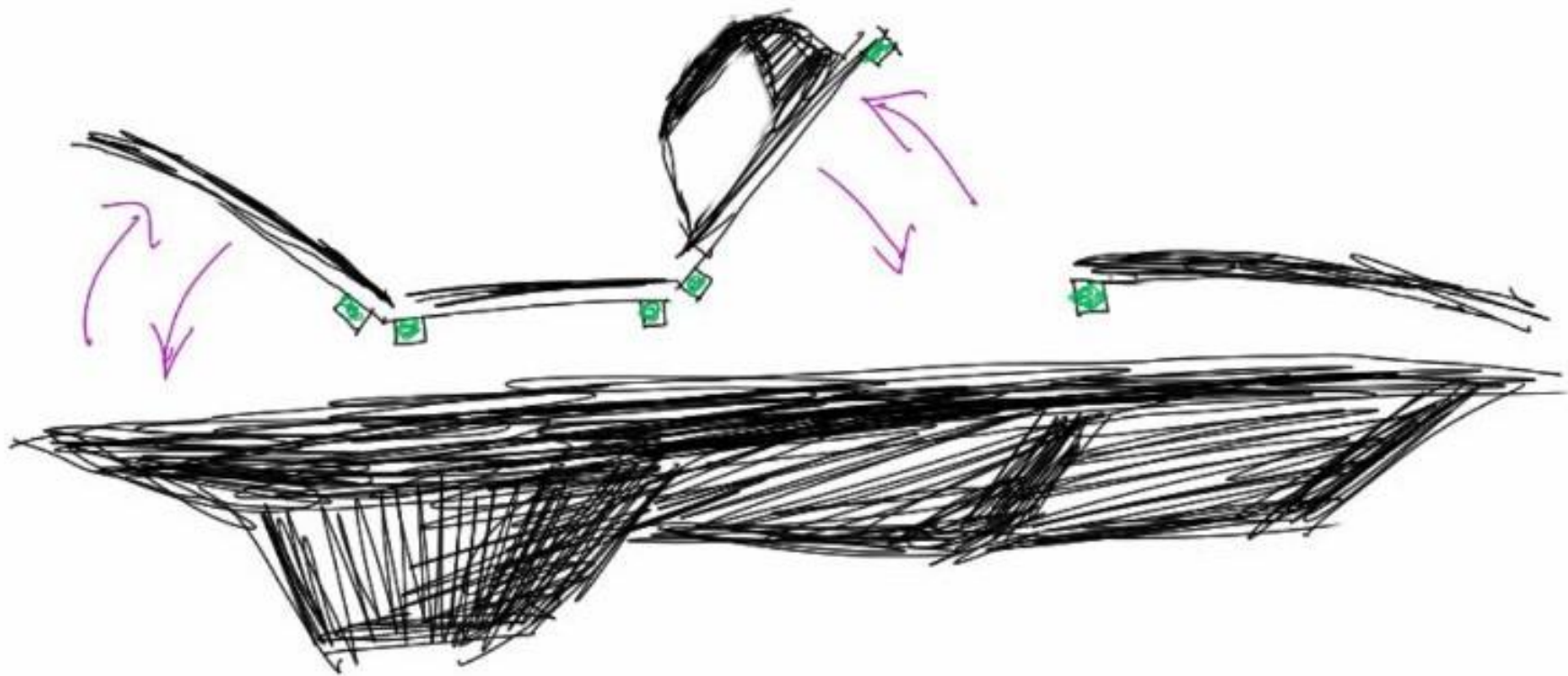



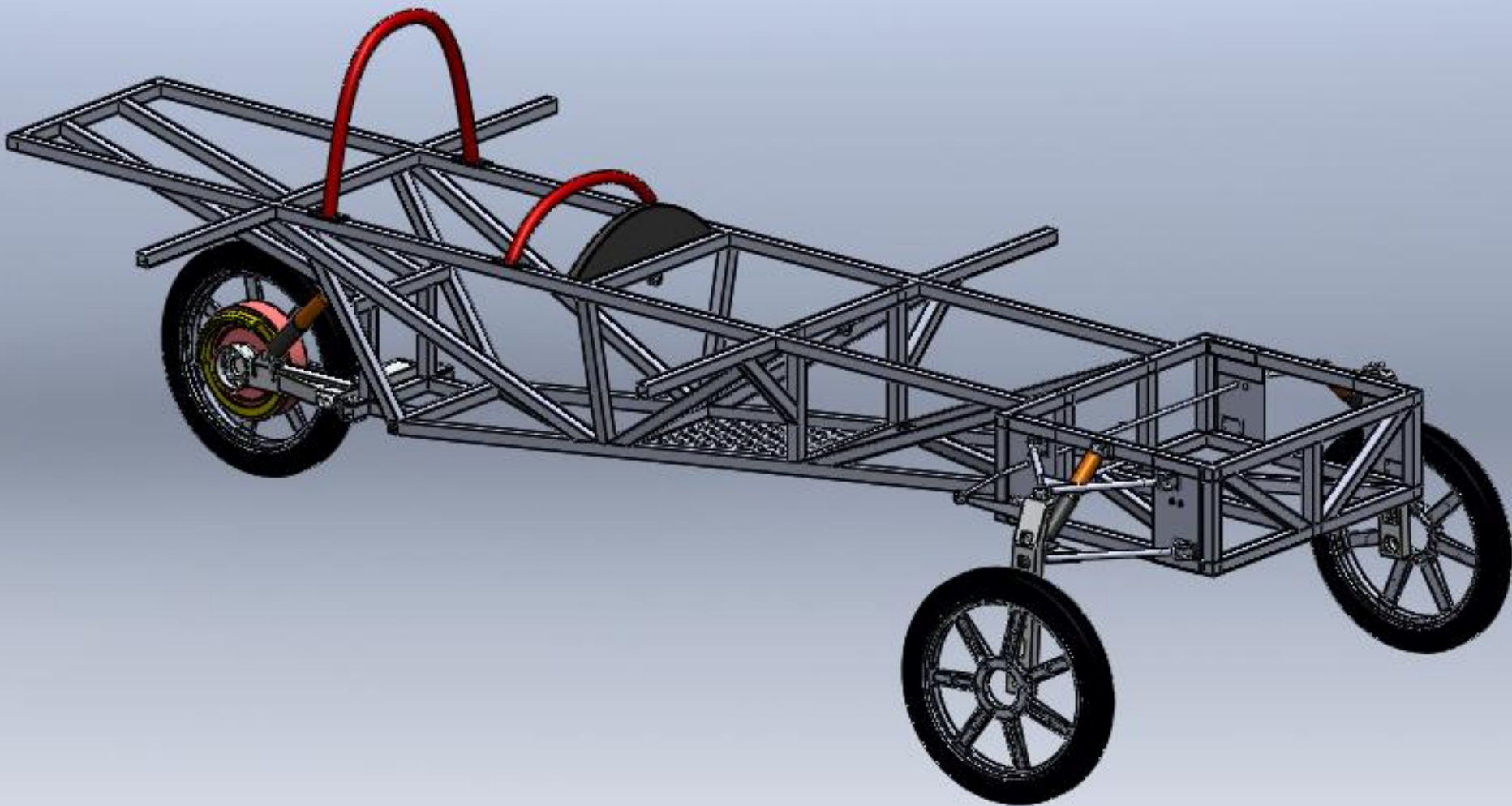

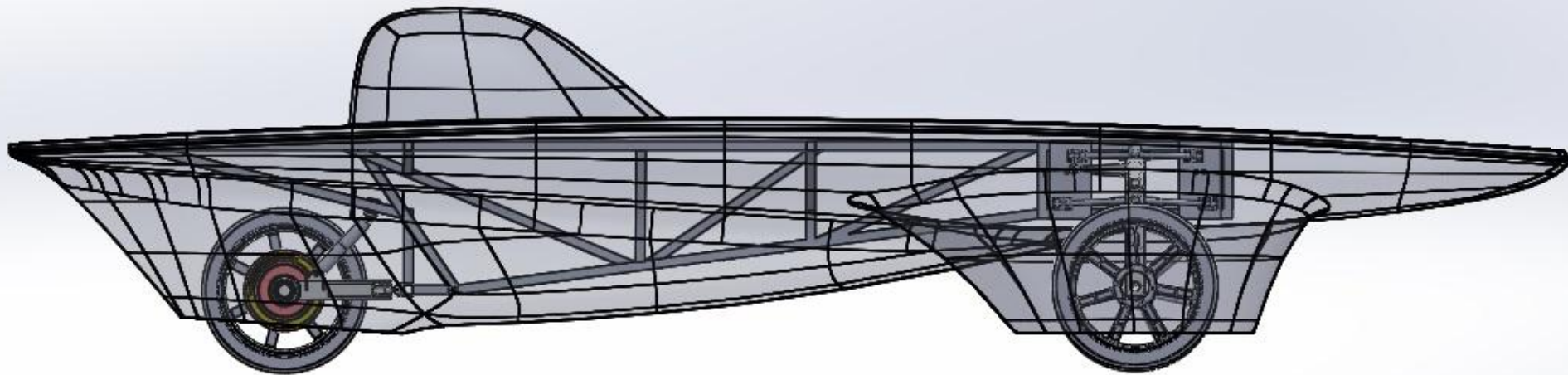
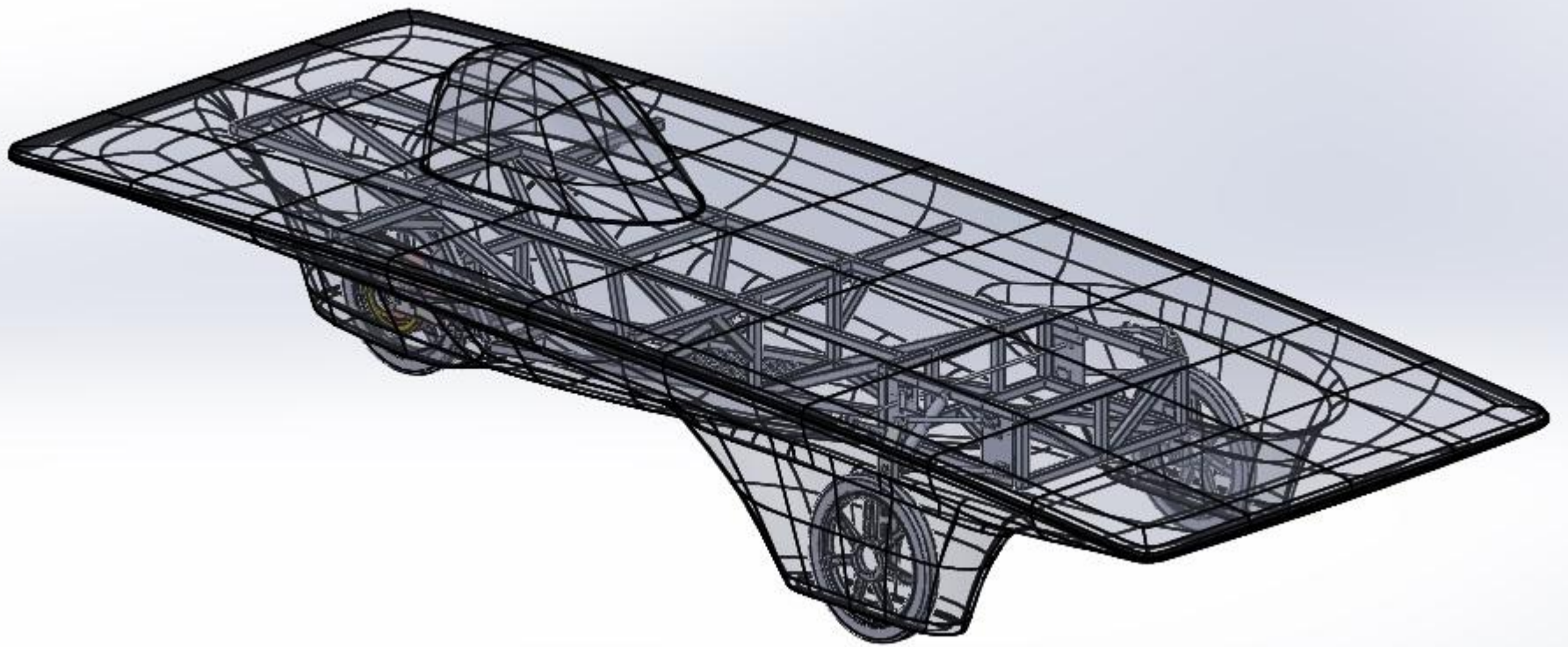



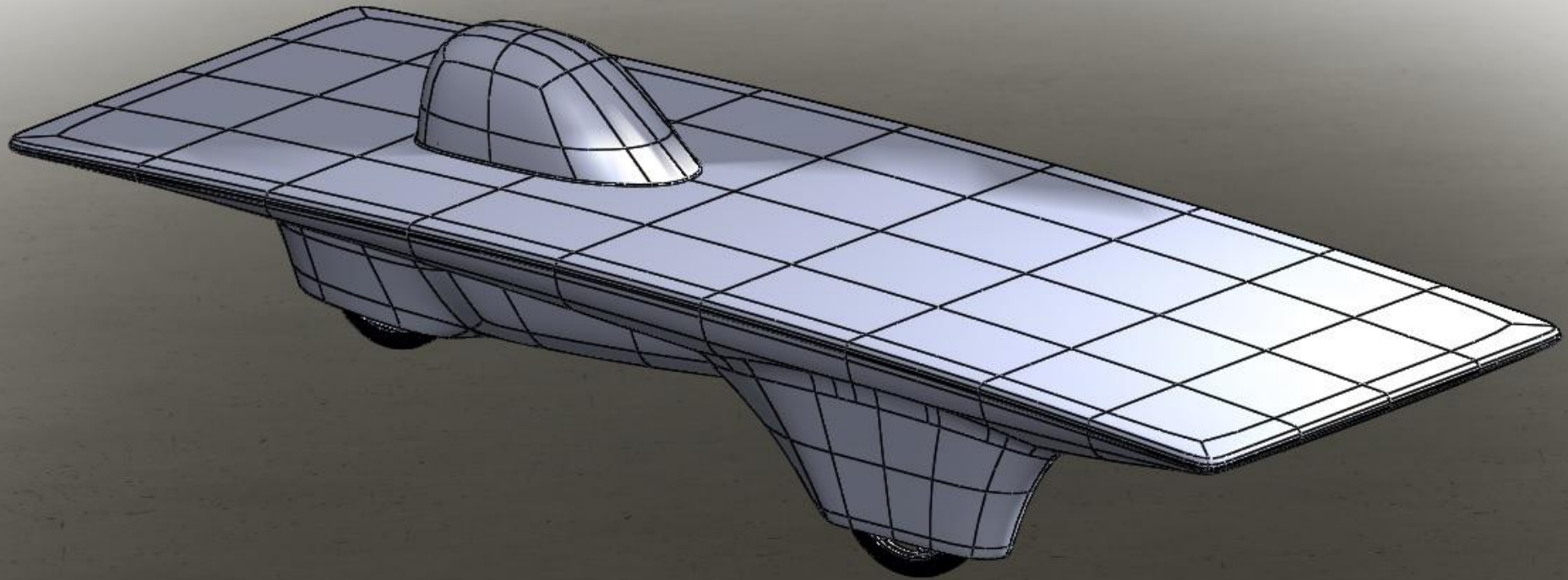

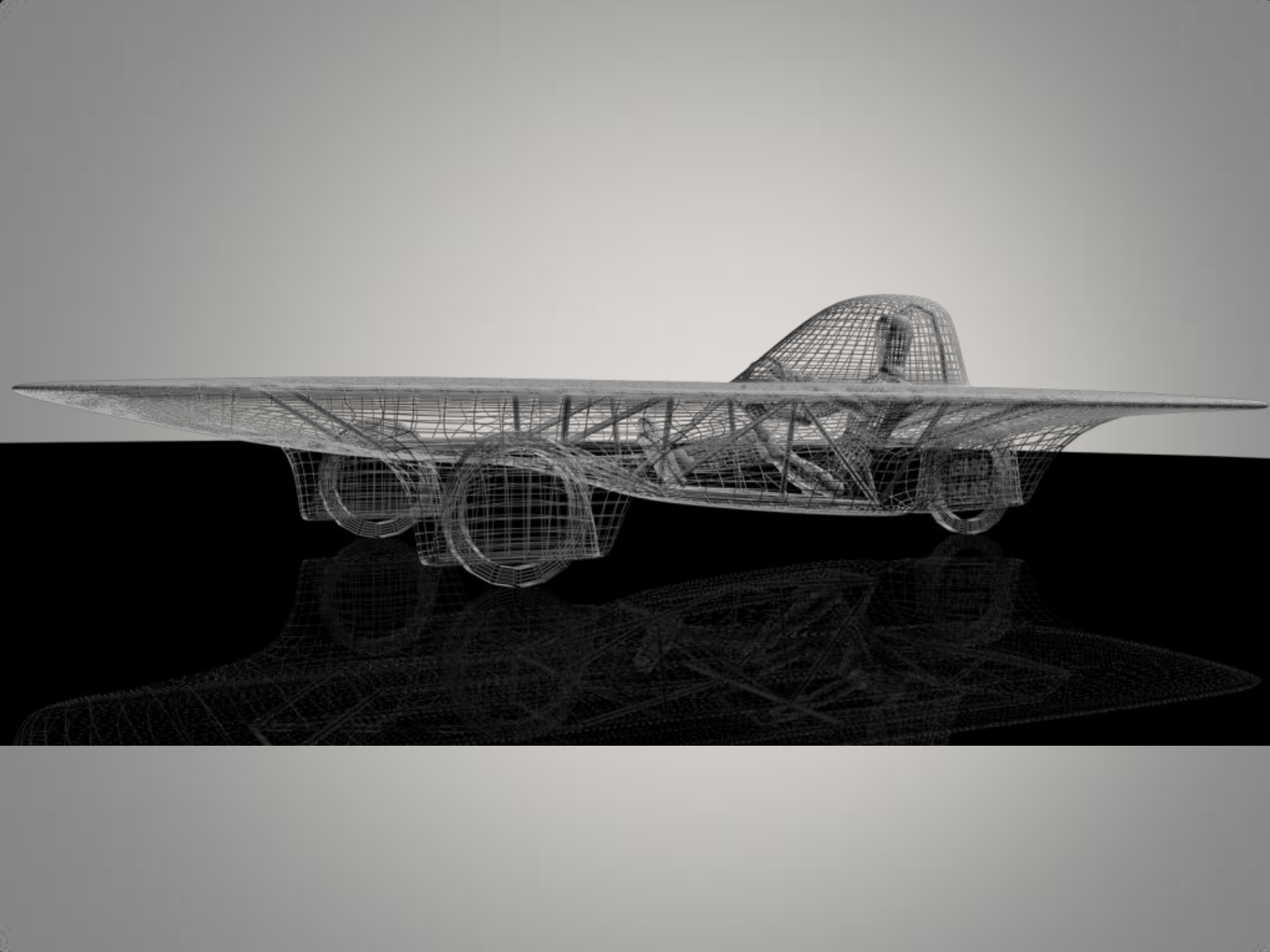



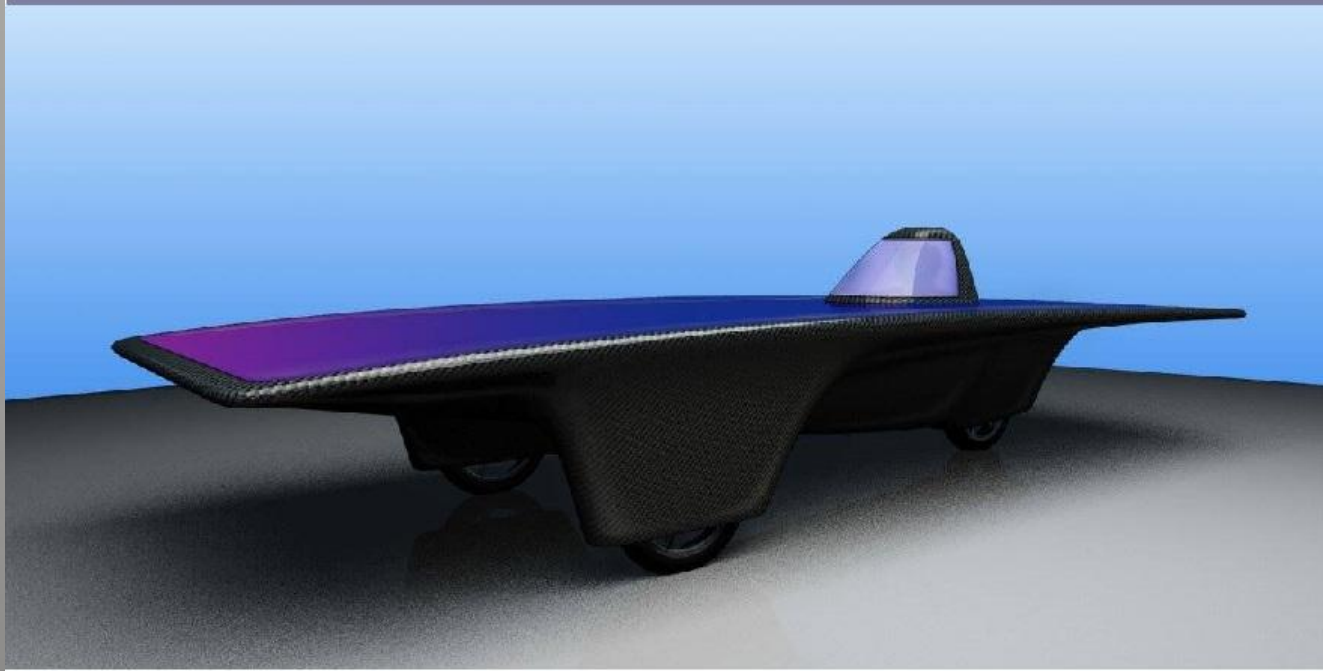
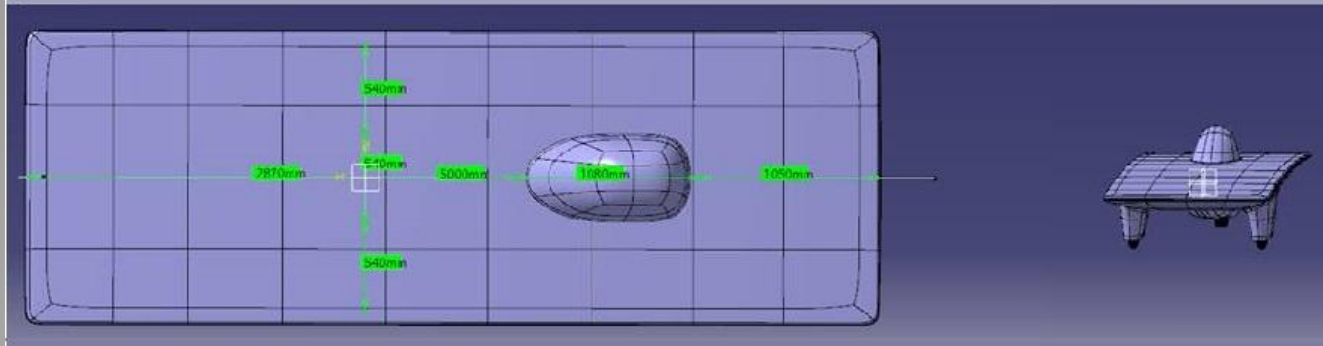
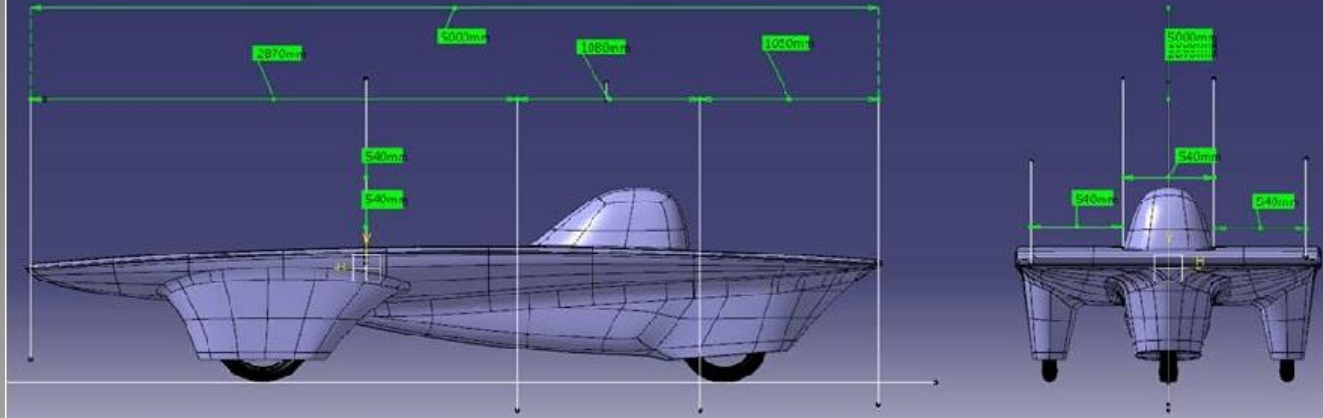

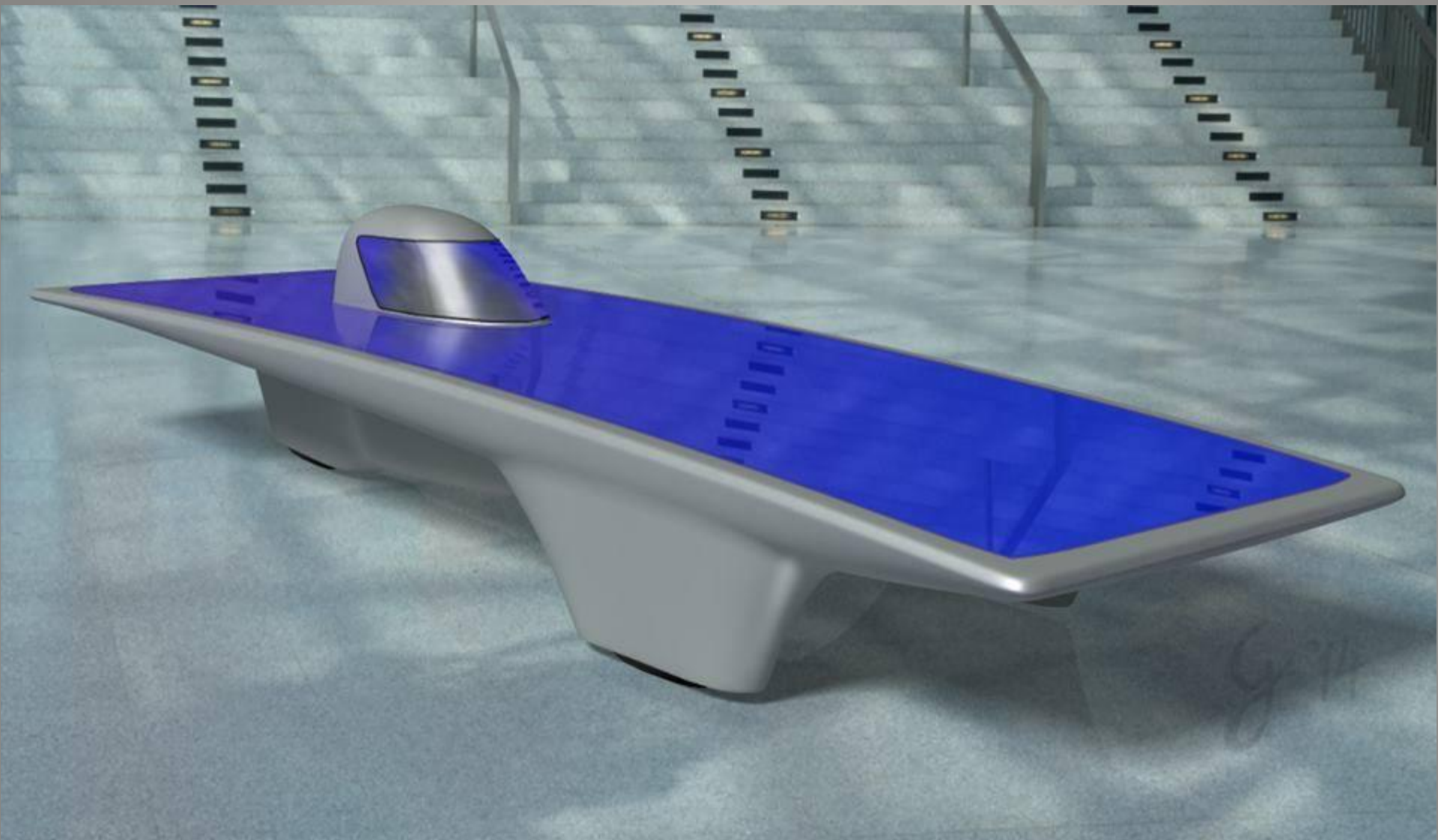

**ŞASE**  
**ve**  
**MEKANİK**





+ Rollbar? [hulyaorob94@yandex.com](mailto:hulyaorob94@yandex.com)

0505 6614948

+ Panel bağlantıları,

+ Karbon Kütük







Ertuğlu gibek Alptekin  
Sarıcaok

Sezer, Gökhan Hoca'ya  
arkadaşım gibek Alptekin  
arrest (sarıcaok)

Sezer, panellere Solid'de  
arabamın Spine sistemini  
tam dükü yapacak

Madenler 10.000 TL  
değerli olacak. Tüketilmeye  
başladı

Ertuğlu'nun ayu  
fatura kesebilir mi?  
Akte sorulacak.

Akteye bakılan işin tamamı  
kaynakçı ile yapılabilir mi?

Rafine, TÜBİTAK formu  
sorulacak

Panellerin bağlanması için  
Uzun ölçüde aynı  
Pul

Smal yalıtım parçaları  
kullanılacak





































SAKIN  
KI





















**GÖVDE**  
**ve**  
**MONTAJ**













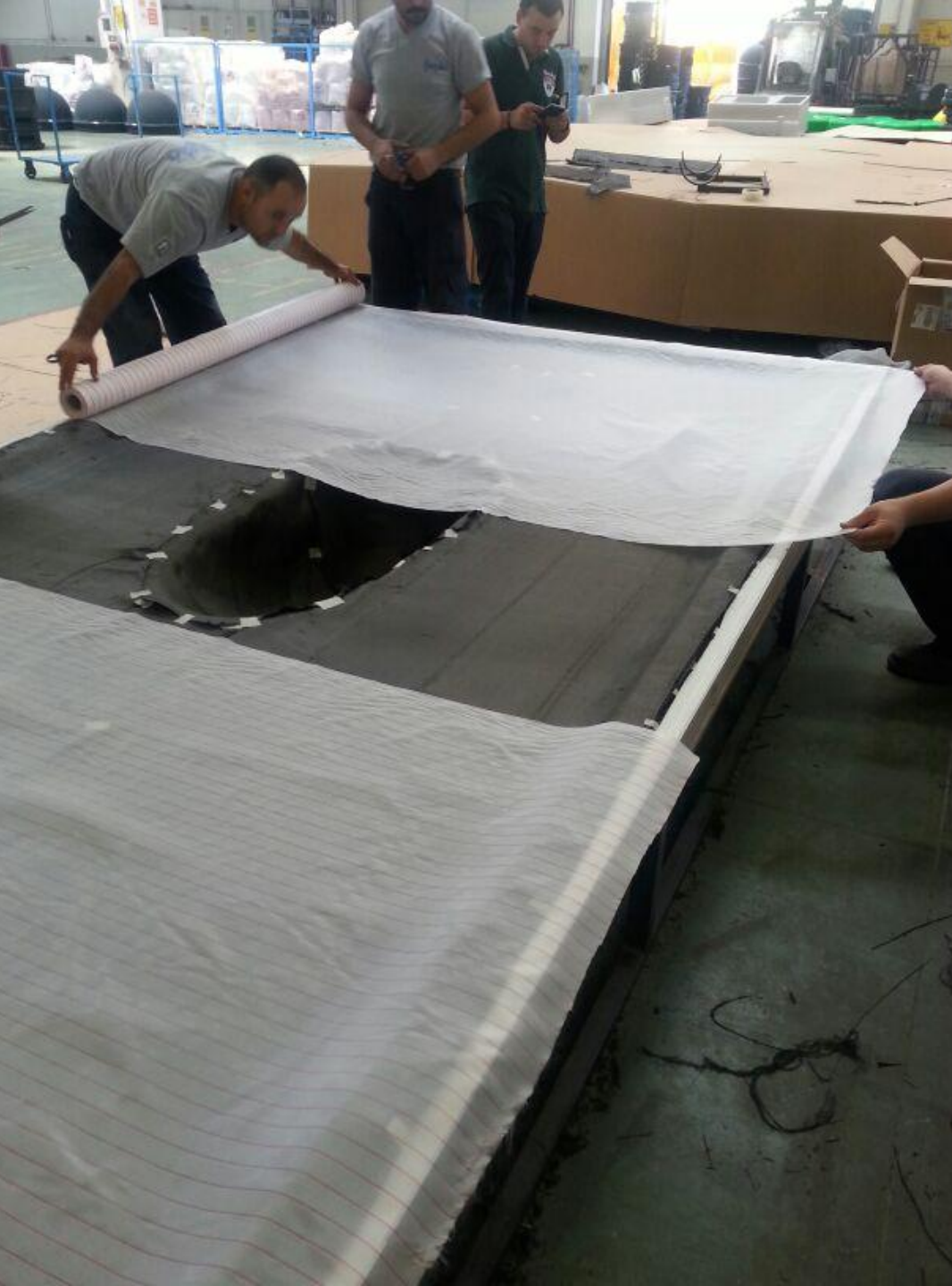































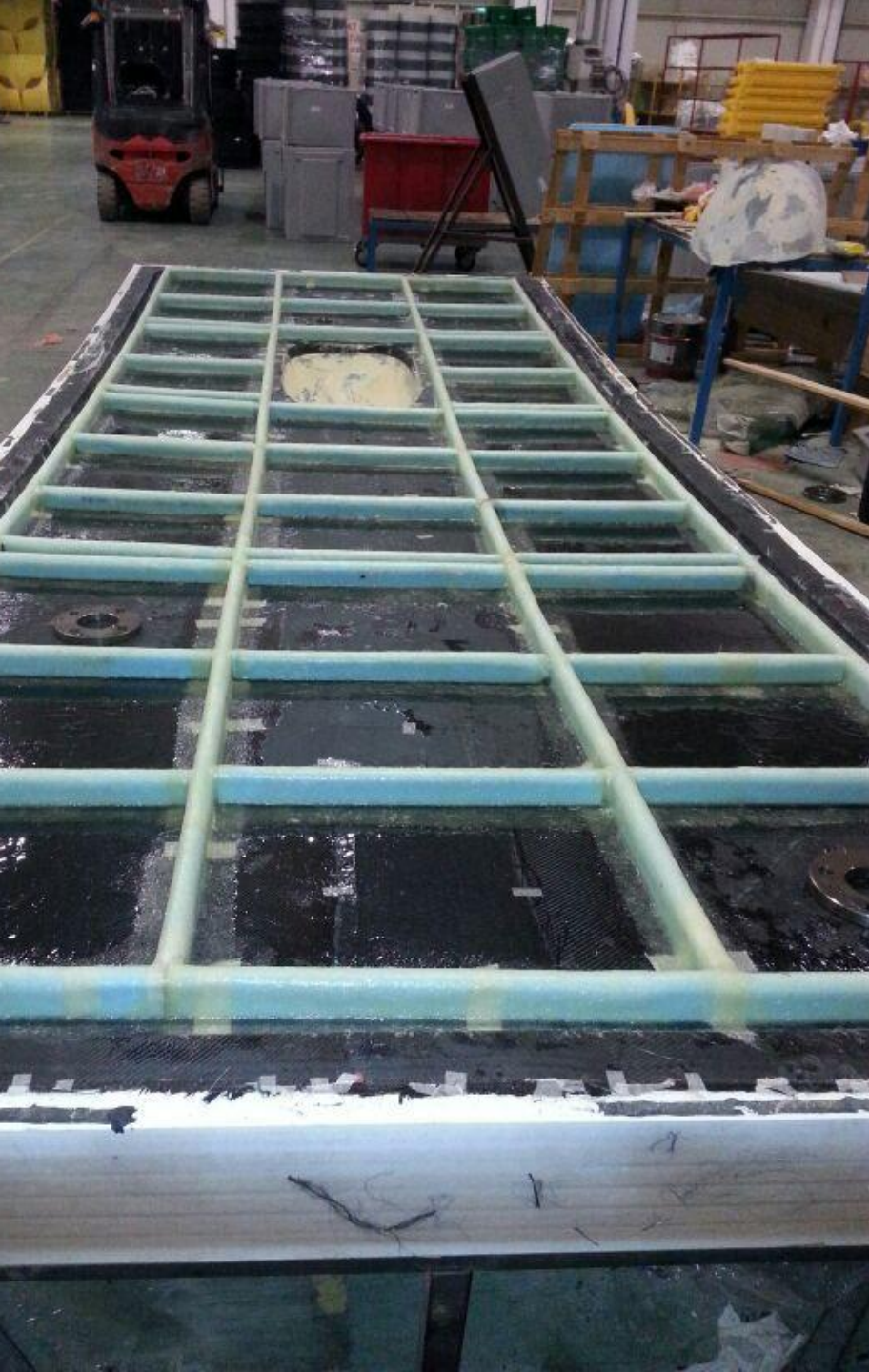























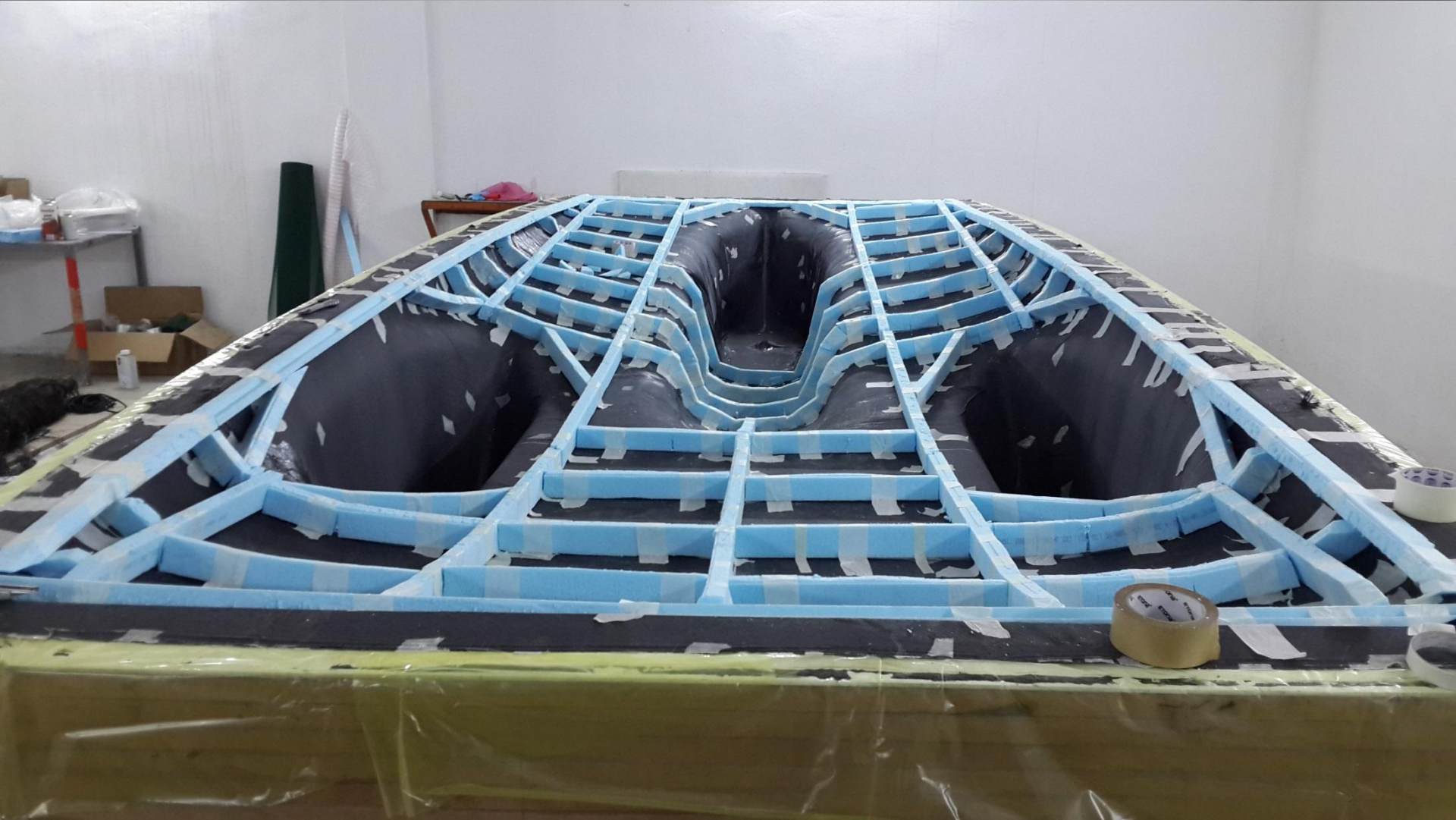















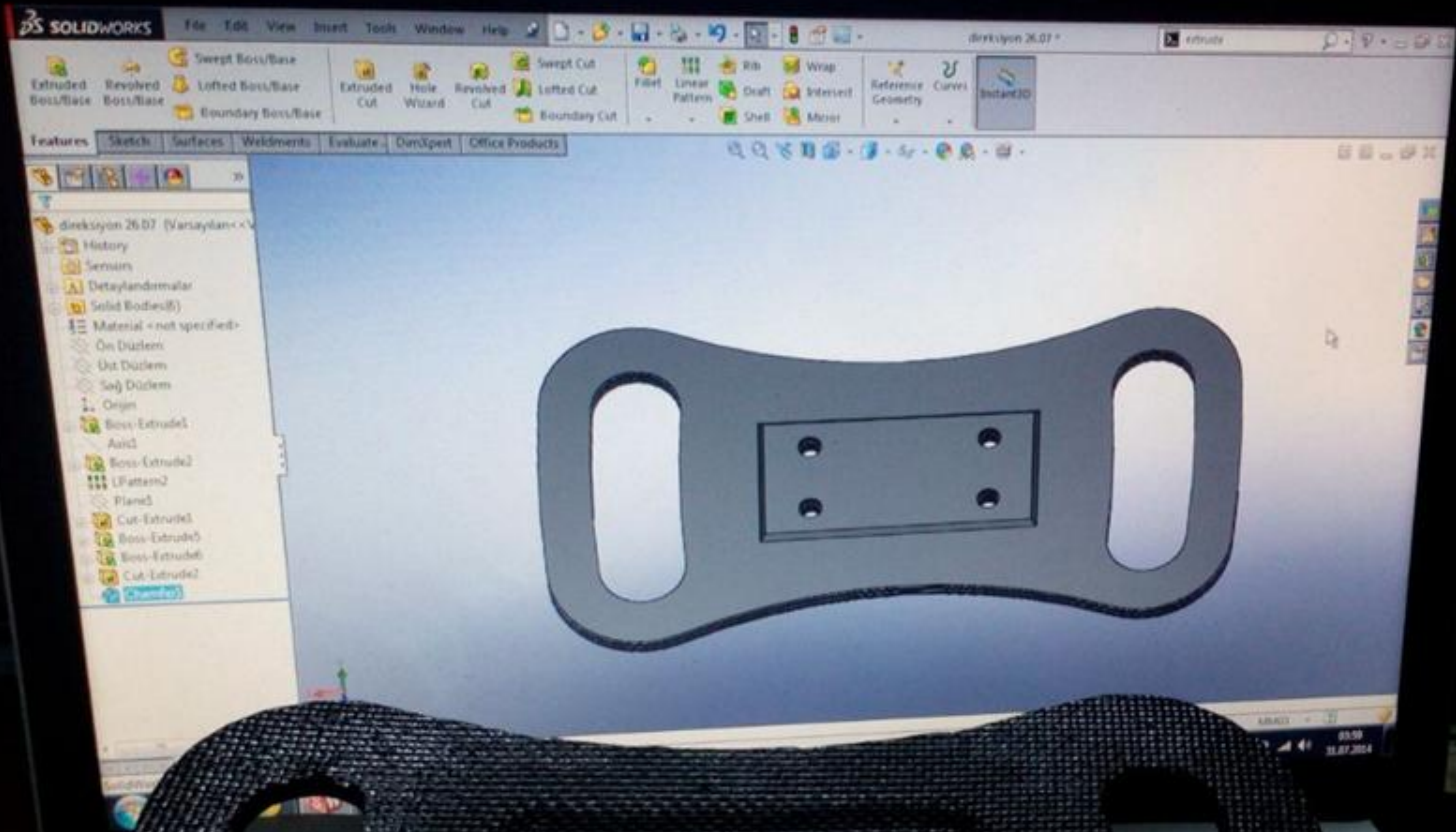





PEHLIVAN

SISTEM BILGISI  
1=00, 22 U=189U

000

Four red buttons on the gear shifter.





















**ELEKTRİK**  
**ve**  
**ELEKTRONİK**





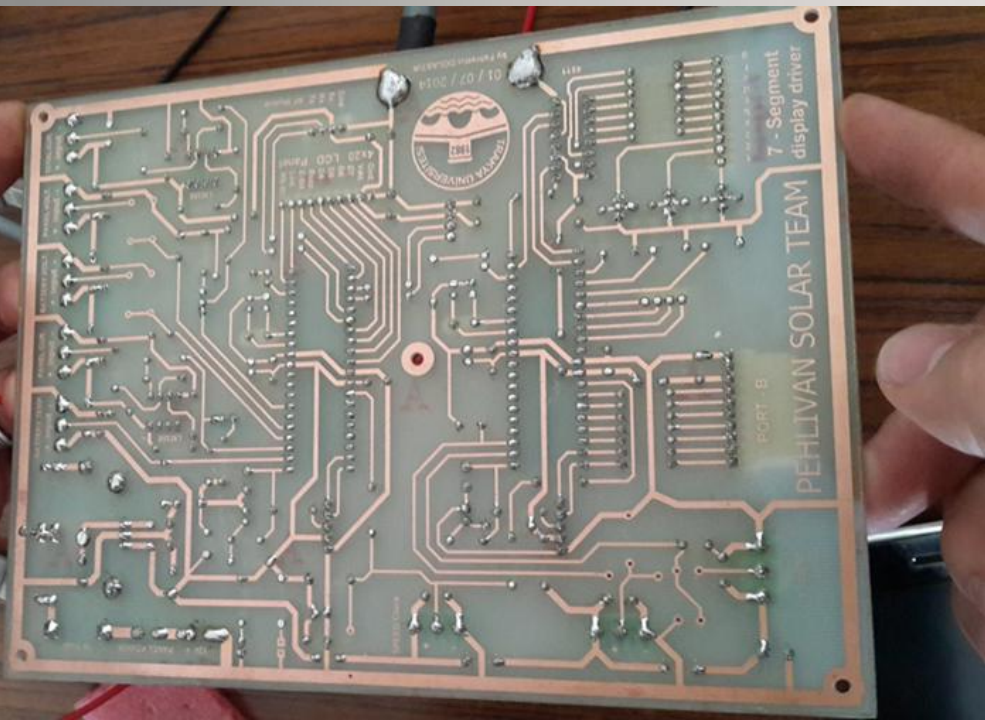
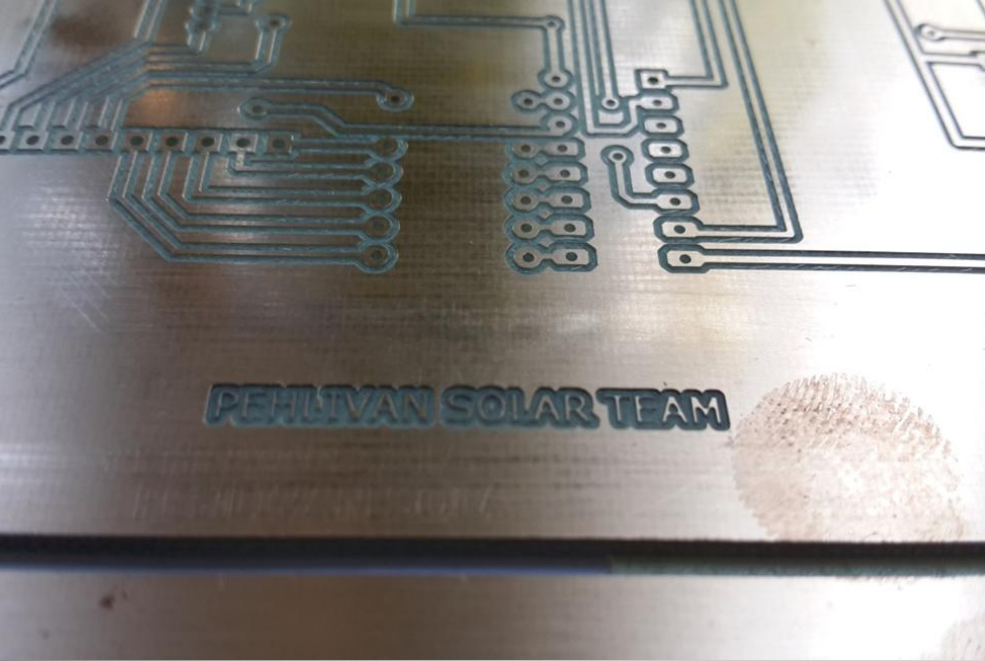

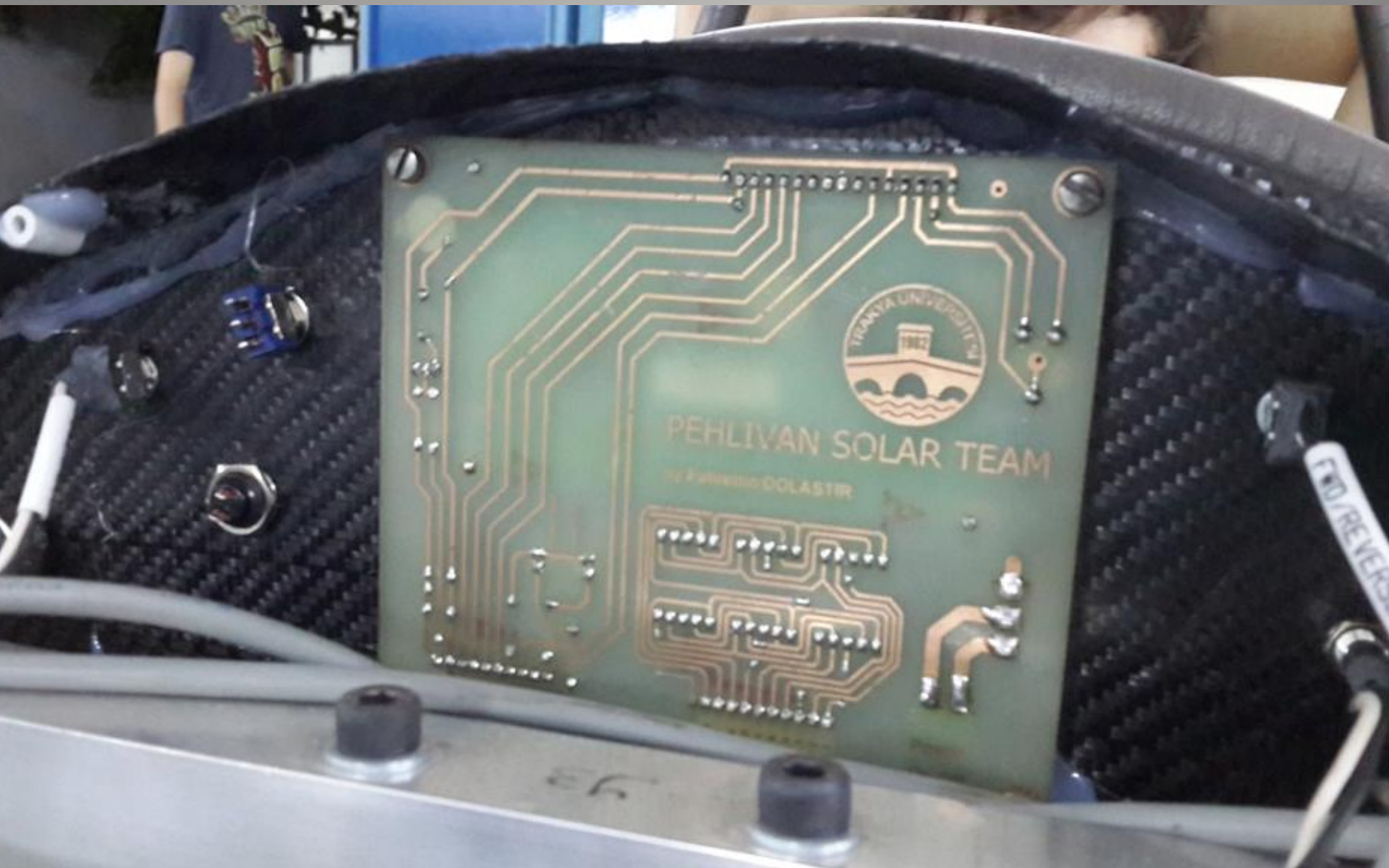

PEHLIVAN SOLAR TEAM

by Fatemeh GOLASTIR

FO/REVER

ER













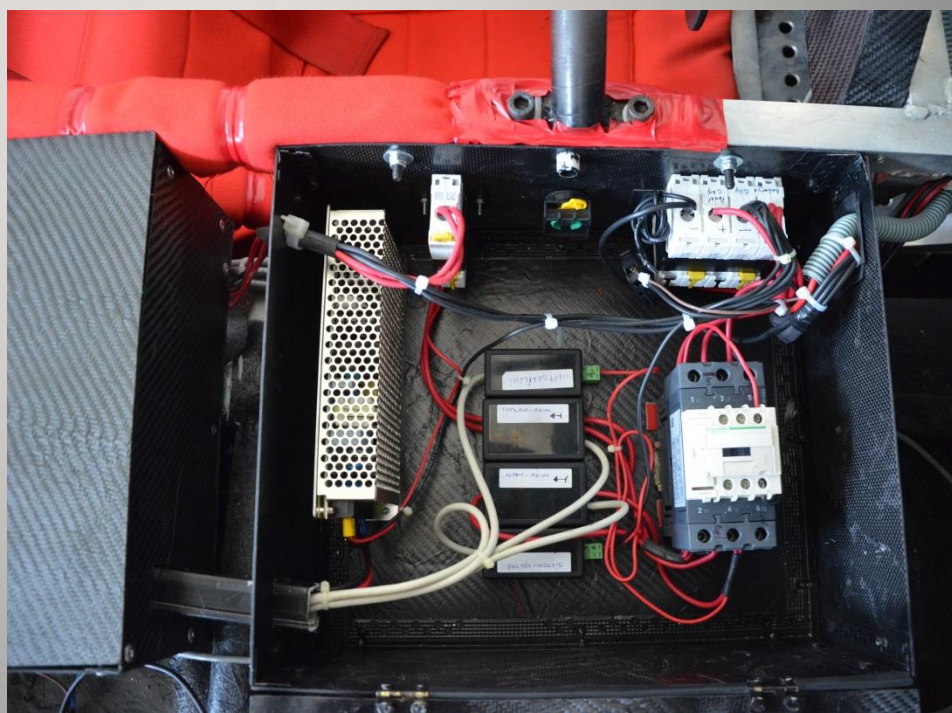
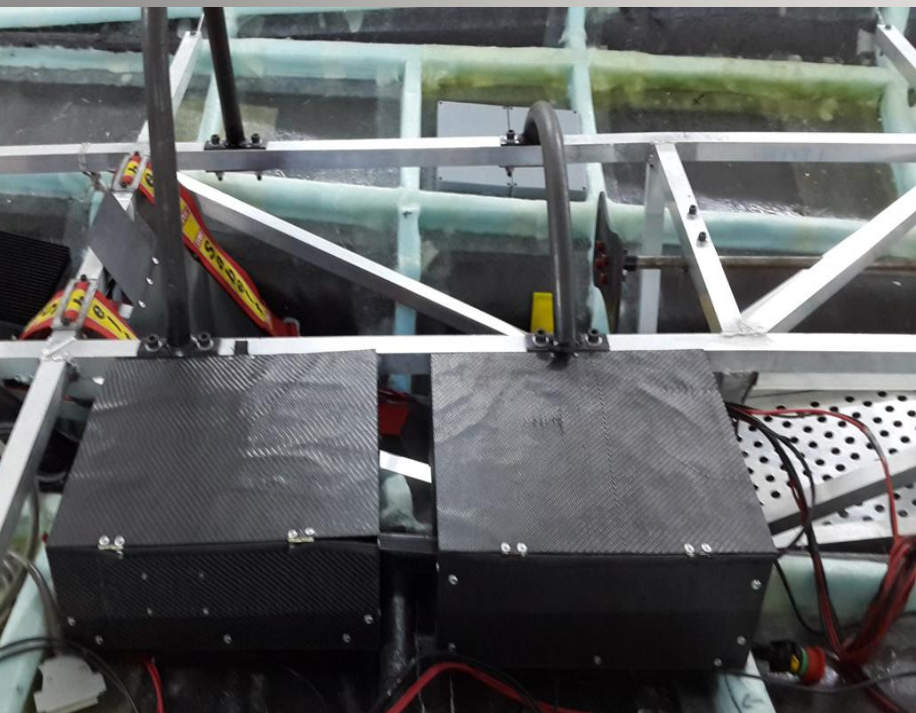
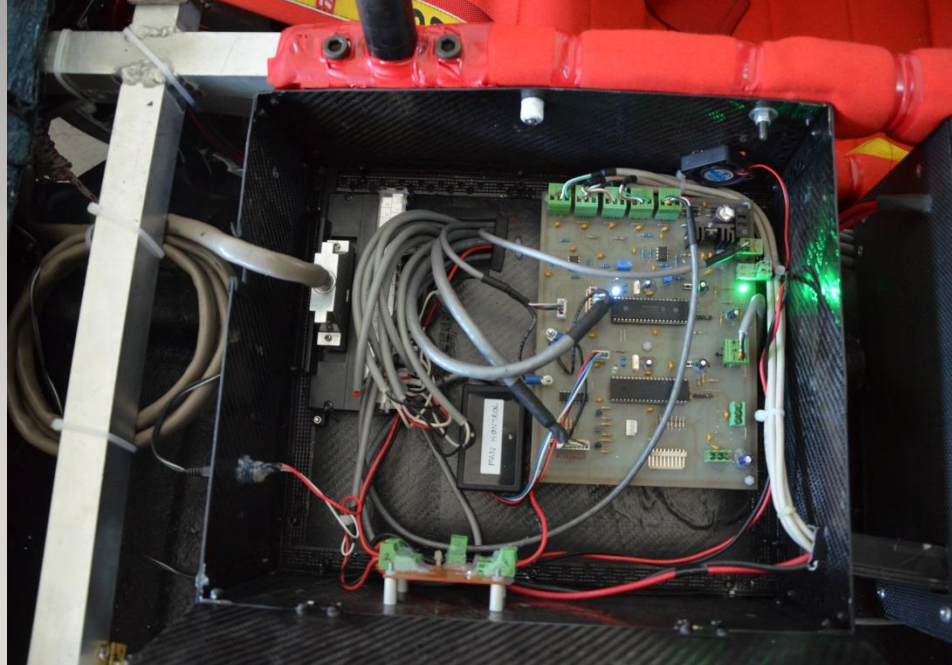



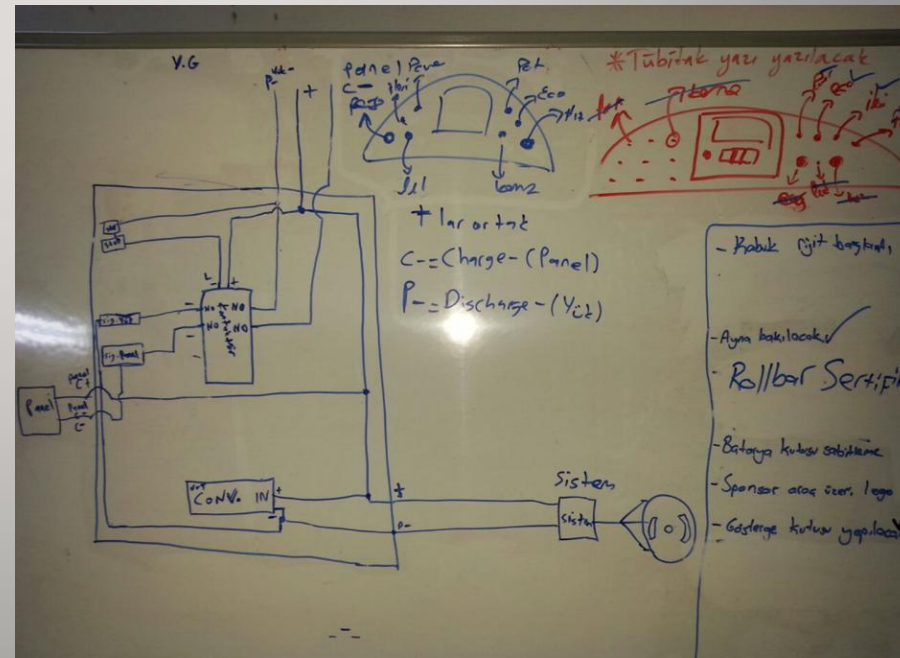
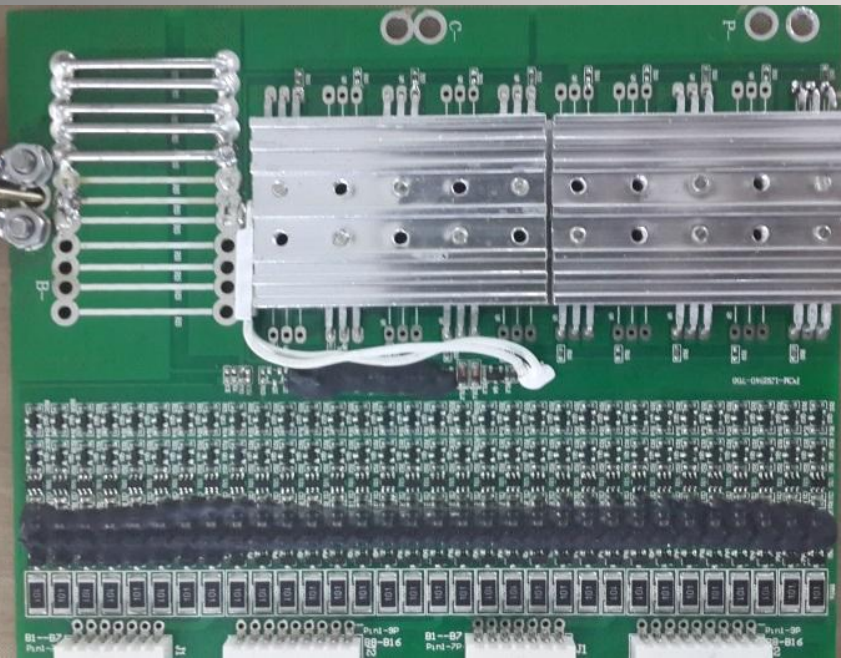
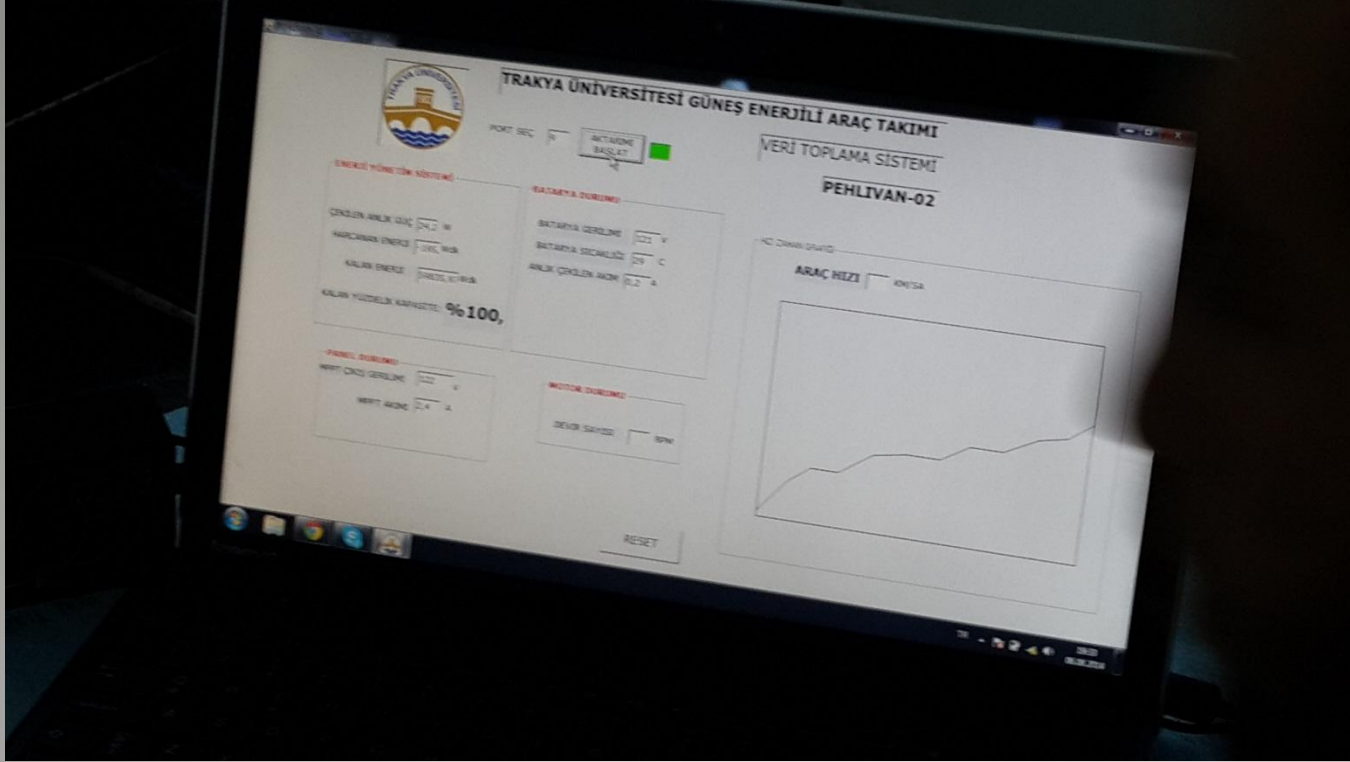

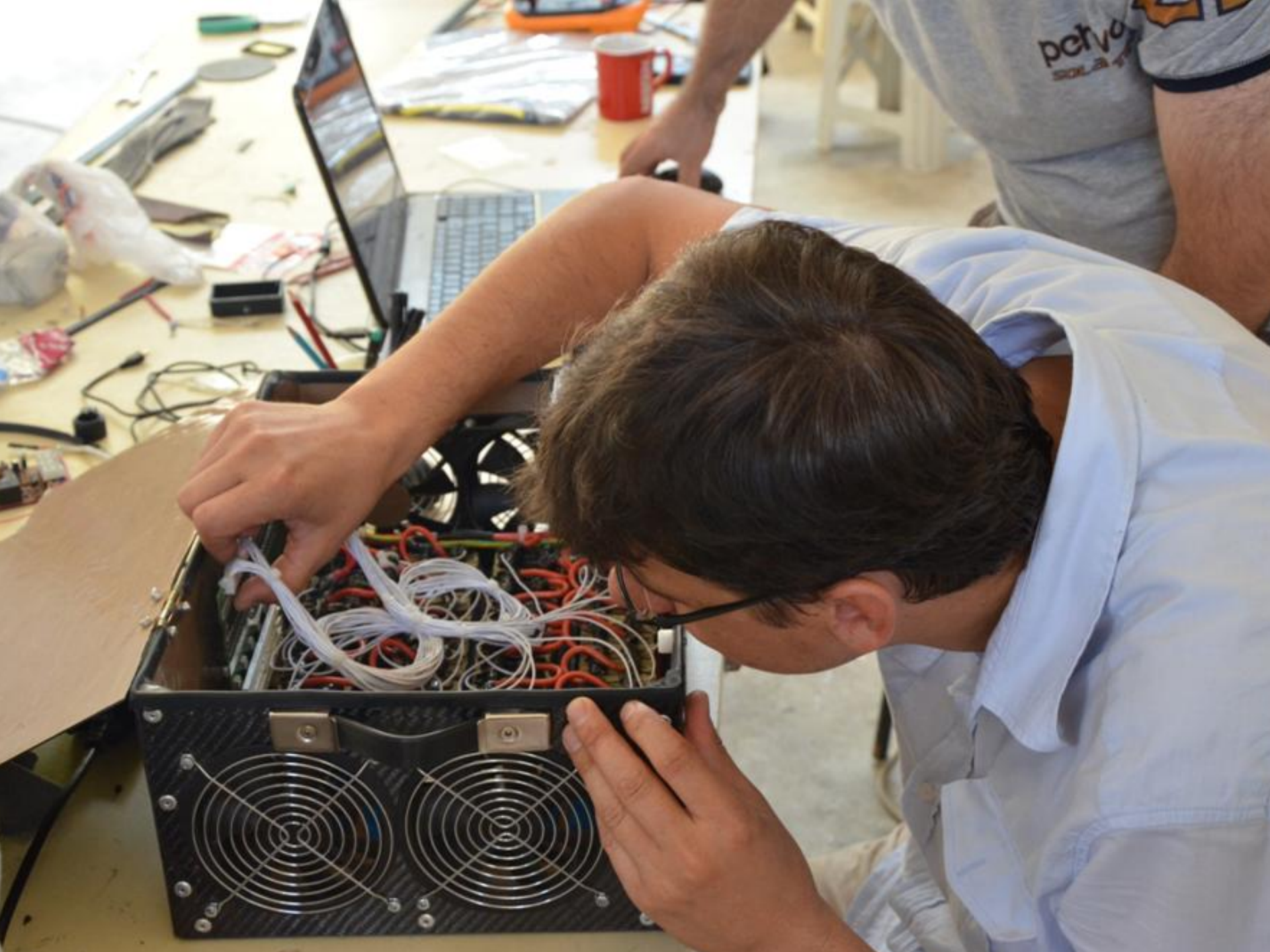



































T.C. TRAKYA ÜNİVERSİTESİ EDİRNE

T.C. TRAKYA ÜNİVERSİTESİ EDİRNE

T.C. TRAKYA ÜNİVERSİTESİ EDİRNE

T.C. TRAKYA ÜNİVERSİTESİ EDİRNE

T.C. TRAKYA ÜNİVERSİTESİ EDİRNE

pehlivan

www.pehlivansolarteam.org

www.pehlivansolarteam.org

170









TRAKYA UNİVERSİTESİ  
SÜREKLİ EĞİTİM  
TİPİ

DOWIKSA  
3M



## HEDEFLERİ WORLD SOLAR CHALLENGE

PEHLİVAN'I inceleyen Trakya Üniversitesi Rektörü Prof. Dr. Yener Yörük, Pehlivan Solar Team öğrencilerinden ve proje danışmanlarından bilgi aldı. Hedeflerinin gelecek yıllarda Avustralya'da düzenlenen dünyanın en önemli güneş arabası yarışları olan World Solar Challenge'a katılmak olduğunu belirten ekip, desteklerinden dolayı Rektör Yörük'e teşekkür etti. Prof. Dr. Yörük, öğrencilerin böylesi bir projede aracın bütün parçalarını üretmelerinin ve projeyi tamamlamalarının bir başarı olduğunu belirterek, öğrencilere bundan sonra gerekli desteği vereceklerini söyledi.



190 kilogramlık Pehlivan 110 bin liraya mal oldu.



TÜ Rektörü Prof. Dr. Yener Yörük

# Pehlivan yarışa hazır

TÜ öğrencilerinin tasarladığı 'Pehlivan' adlı güneş enerjili elektrikli araç, İzmir'deki Formula-G yarışında piste çıkacak. Öğrencilerin hedefi kupayı alıp Avustralya'daki

Trakya Üniversitesi (TÜ) Tasarım Proje Topluluğu öğrencilerinin ürettiği 'Pehlivan' adlı güneş enerjili elektrikli araç, Edirne'yi Formula-G yarışında temsil edecek. Takım kaptanı ve aracın sürücüsü Ali Dereoğlu, 'Pehlivan'ın, katılacağı TÜBİTAK'ın düzenlediği yarışın bugün başlayacağını ve 17 Ağustos'a kadar süreceğini söyledi.

## 8 AYDA TAMAMLANDI

Dereoğlu, Pehlivan Solar Team takımının aracının, 4 akademik danışman,



SABAN

çalışmalarıyla, 8 ayda tamamlandığını belirtti. "Aracımızın motor, panel ve batarya hariç tamamını kendi üretimimiz" diyen Dereoğlu "Motorumuz, panellimiz ve bataryamız Türkiye'de ciddi rekabet yaratacak kaliteye sahip. Aracımıza güveniyorum."

Pehlivanlar diyarı Edirne'ye yakışır bir isim olduğu için 'Pehlivan' dedik. Rakiplerimize bu korkuyu, bu çökengeniği hissettirmeye başla-

Dereoğlu, araçlarının hesaplarına göre, 75 kilometre hızla ilerleyeceğini söyledi. Dereoğlu, şöyle devam etti:

"Tabii araç ortaya çıkartırken maddi destekler de gerekti. Bunları sponsorlarımız aracılığıyla giderdik. Aracımız güneş enerjisiyle çalışan, batarya destekli bir elektrikli araçtır. TÜBİTAK'ın belirlediği kurallar gereğince 1 kilovat/saatlik bir batarya kapasitemiz var. Biz bu batarya kapasitesiyle ve yarış koşullarını göz önünde bulundurarak, 46 dakika aracımızın batarya destek-



Pehlivan'ın sürücüsü Ali Dere-





# FORMULA-G 2014

İzmit Körfez Yarış Pisti





TÜBİTAK



# ALTERNATİF ENERJİLİ ARAÇ YARIŞLARI



TÜBİTAK



SHIBA



# pehlivan

## SOLAR Team

#guncelip  
Pehlivan Solar Team  
@pehlivanteam

Pehlivan Solar Car Team  
TRAKYA ÜNİVERSİTESİ

ARI TÜBİTAK  
GÜNEŞ ARABALARI YARIŞI



COLIN'S



















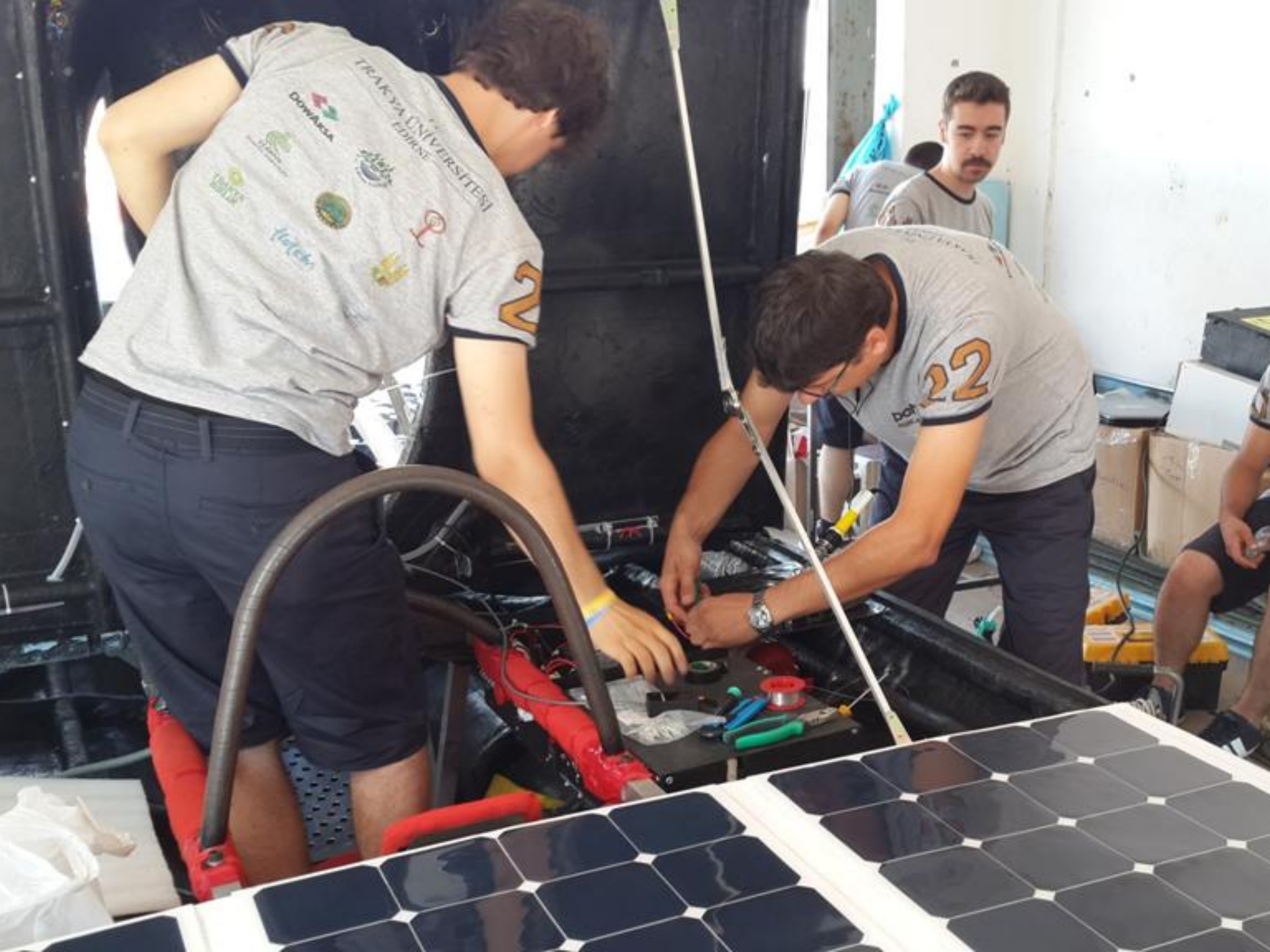







T.C.  
TRAKYA ÜNİVERSİTESİ  
EDİRNE

DOWAKSA



Hafıza

TRAKYA ÜNİVERSİTESİ





pehlivan

[www.pehlivansolarteam.org](http://www.pehlivansolarteam.org)









T.C.  
TRAKYA ÜNİVERSİTESİ  
EDİTÖR

DOMA SA

TRAKYA





KRİSLARI

Formula G  
GÜN ABALARI YARIŞI

Elektr mobil

Hidr mobil

Formula G  
GÜN ABALARI YARIŞI

Formula G

Formula G

Formula G

Formula G

Formula G

T

LIVAN













EMİYATIF ENERJİ

YEREL YATIRIMCI İNCELEME VE DEĞERLENDİRME

pchlivan

www.pchlivansolarteam.org

www.pchlivansolarteam.org









TÜBİTAK

22

A. DEROĞLU (0 Rth +)

Sparco





**Formula G**  
GÜNEŞ ARABALARI YARIŞI







Formula G



Hidromobil



Elektromobil

Formula G  
SÜREKLİ ARABALARI YARISU



TÜBİTAK ALTERNATİF ENERJİLER



NATİF ENERJİLİ



**FormulaG**  
GÜNEŞ ARABALARI YARIŞI

Elektröomobil



YENİLENEBİLİR ENERJİLİ ARAÇ YARIŞLARI





FormulaG  
GÜNEŞ ARABALARI YARIŞI



Hidro mobil



Elektromobil

FormulaG  
GÜNEŞ ARABALARI YARIŞI



TÜ





**FormulaG**  
GÜNEŞ ARABALARI YARIŞI



**Hidro mobil**



**Elektromobil**

**Form**  
GÜNEŞ ARABALARI







Hidromobil

TÜBİTAK Formülasyon

Elektromobil

22

26





22



Pepels

DOWAKSA

3M



































T.C. TRAKYA ÜNİVERSİTESİ  
EDİRNE

T.C. TRAKYA ÜNİVERSİTESİ  
EDİRNE

T.C. TRAKYA ÜNİVERSİTESİ  
EDİRNE

22



  
**TRAKYA ÜNİVERSİTESİ**  
Tasarım ve Proje Topluluğu

[facebook.com/trakyauniv](#)  
[trakyauniv.com](#)

Solar Car Team  
ÜNİVERSİTESİ





TERNATİF ENERJİ

YARISLARI



**FormulaG**  
GÜNEŞ ARABALARI YARIŞI

Elektrömobil





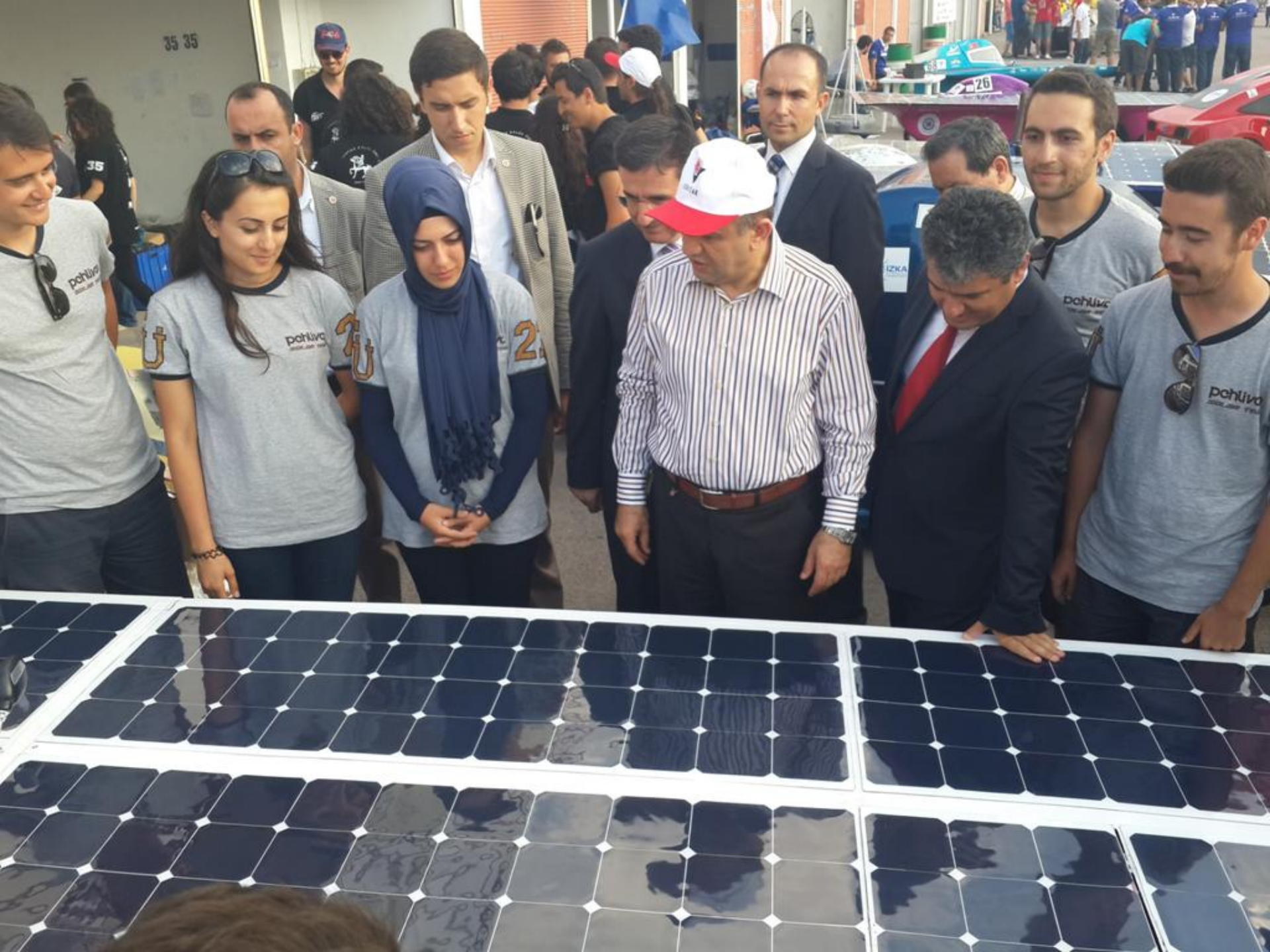



ALTERNATİF ENERJİLİ  
ARAÇ YARIŞLARI 2014  
KÖRFEZ YARIŞ PİSTİ - KOCAELİ



BİTAK

Hidromobil



TÜBİTAK



ALTERNATİF ENERJİLİ  
ARAÇ YARIŞLARI 2014  
KÖRFEZ YARIŞ PİSTİ- KOCAELİ

Elektromobil  
FormuLaG  
KÖRFEZ ARABACILARI YARIŞI  
Hidromobil









ALTERNATIF ENERJİLİ  
ARAÇ YARIŞLARI 2014  
KÖRFEZ YARIŞ PİSTİ - KOCAELİ

TÜBİTAK

















B2TOSHIBA

TRAKYA ÜNİVERSİTESİ  
Arz ve Proje Topluluğu

TRAKYA ÜNİVERSİTESİ PEHLİVAN SOLAR TEAM



Formula  
BALARI YARIŞI



ULUSOY  
AYHAN ULUSOY



floteks

DOWAKSA

3M



@pehlivanteam  
#gunesimpehlivanlari

Pehlivan Solar Team



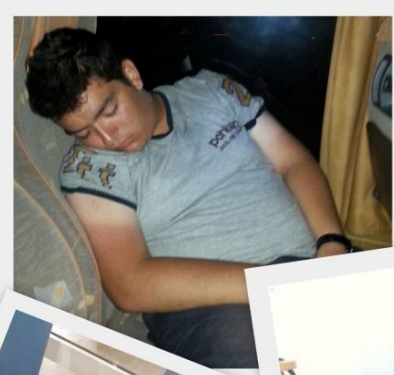
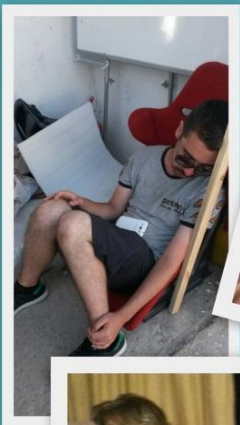



**46MEDYA**  
Habersiz Kalma

Siyaset Ekonomi Eğitim

SON DAKİKA 18:15 - Sır

Google

Televizyon frekansları  
interneti koşturdu (Türk)

10. Alternat

Trakya Üniversite  
Tarihçesi

**AVRUPA**

ANA SAYFA SON DAKİKA

Avrupa Web TV News in E

Ana Sayfa | TÜRKİYE

'Pehlivan' Tür

1  
3  
Hat

Trakya  
Fakültesi  
Toplantı  
üyesi  
ürettiler

8 ayda 'Pehlivan' ürettikler



# GÜCÜNÜ GÜNEŞTEN ALAN PEHLIVAN



**HABER**  
Türkiye

Yünya Siyaset

1.08.2014-12:00

yerli

Yazarlar Program

rettikler

nci,  
atılmak için 8  
trikli aracı





Bize inananlara Teşekkür Ederiz.



floteks®



TRAKYA  
BİRLİK



EDİRNE-TÜRKİYE



EDİRNE  
BELEDİYE BAŞKANLIĞI

